

SUPRACLEAR

CONVERTING FILMS
VACUUM POUCHES
DOYPACK POUCHES

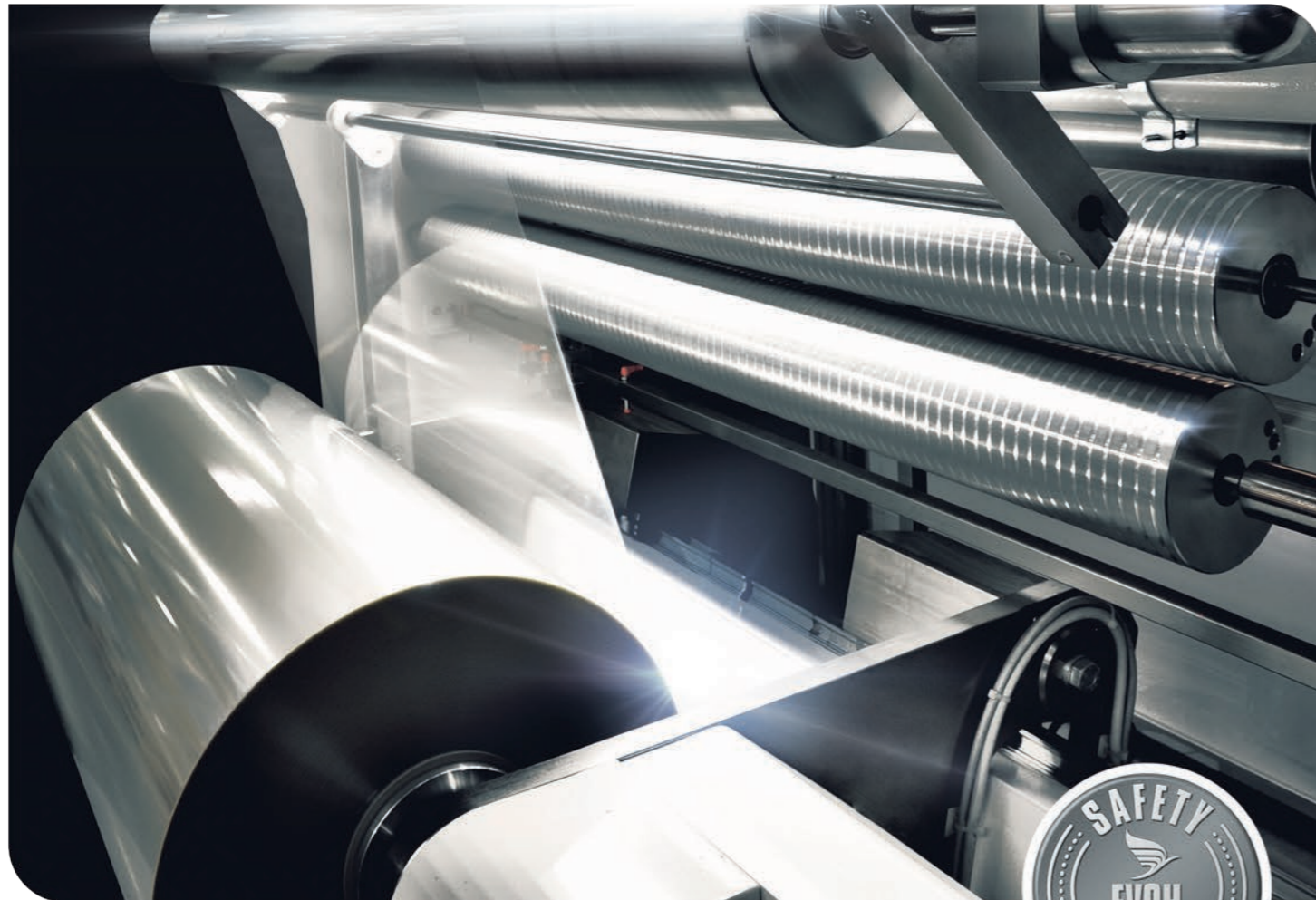

APPLICATION

- Film for lamination
- Film for vacuum pouches
- Packing of food products

ADVANTAGES

- Very good sealability
- Oxygen and water vapour barrier
- Very good barrier to gases (EVOH)
- High transparency and gloss

POUCH FILMS

SYMBOL	COMPOSITION	THICKNESS RANGE (µm)	SIZE RANGE (mm)	OTHERS
RFJ	PP, EVOH, PE	65, 90	150-2150	PE seal, for the production of vacuum bags
XBA	PA, PE	55-160	150-3200	for the production of vacuum bags

TRUSTWORTHY PACKAGING



FILMS FOR LAMINATION

SYMBOL	GLL	GLA, GLB, GLC	GLD, GLE, GLF	GLR	GLO	GLN	GLJ
COMPOSITION	EVOH, PP	PA, EVOH, PE	EVOH, PE	PE	EVOH, PE	PE	PE, PA, EVOH, PP
THICKNESS RANGE (µm)	40	25-50	30-80	50	50	40-80	30
SIZE RANGE (mm)	150-2000	150-2000	150-2000	150-2000	150-2000	150-2000	150-2000
OTHERS	PP seal	PE seal, antifog option, easy peel, high barrier	PE seal, antifog option, easy peel, high barrier	PE seal, reclosable, dedicated to the dairy industry	PE seal, reclosable, high barrier, dedicated to the meat industry	PE seal	PP seal, high barrier

VACUUM POUCHES

SYMBOL	RJW, RJO	WAW, WAO	WBL
COMPOSITION	PP, EVOH, PE	PA, PE	BOPET//PE; BOPET//PA, PE; BOPET//PA, EVOH, PA, PE; BOPETmet//PE
THICKNESS RANGE (µm)	65, 90	55-160	from 52
LENGTH RANGE (mm)	175-1200	175-1200	150-950
WIDTH RANGE (mm)	100-400	100-800	100-580

PRODUCTS MARKED WITH A GREEN LEAF ARE THE RESULT OF IMPLEMENTING THE 5-POINT ECOSTRATEGY WHICH STRIVES TO REACH CIRCULAR ECONOMY.

AVAILABILITY OF COLOURS



WE OFFER



SURFACE PRINT

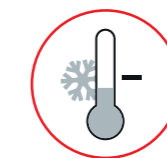

DEEP FREEZING

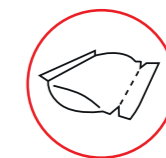

EASY OPEN



EURO HANGER

WE DESIGN SOLUTIONS ACCORDING TO INDIVIDUAL CUSTOMER NEEDS



DOYPACK AND ZIPPER POUCHES

TRUSTWORTHY PACKAGING

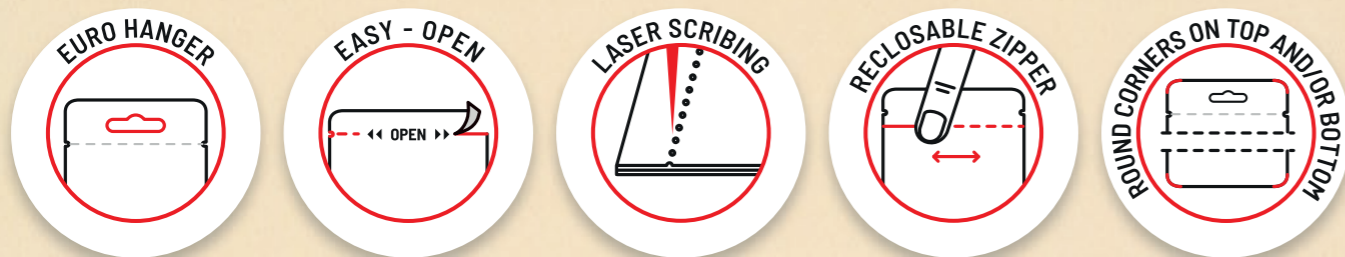

DOYPACK AND ZIPPER POUCHES

TRUSTWORTHY PACKAGING

DOYPACK

SYMBOL	WD	
MATERIAL	coex PA/PE	DUPLEX TRIPLEX MONO FOR RECYCLING
THICKNESS (µm)	from 65	from 42
HEIGHT H (mm)	200-540	200-540
WIDTH A (mm)	100-250	100-250
DEPTH B (mm)	30-70	30-70

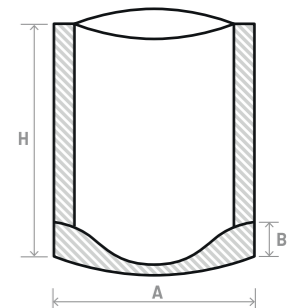

ZIPPER POUCHES

SYMBOL	WS	
MATERIAL	coex PA/PE	DUPLEX TRIPLEX MONO FOR RECYCLING
THICKNESS (µm)	from 65	from 42
HEIGHT H (mm)	200-540	200-540
WIDTH A (mm)	100-250	100-300

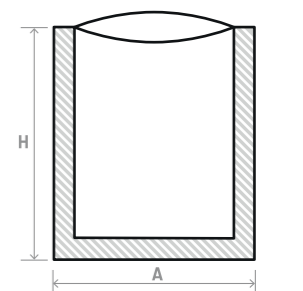

WE OFFER  SURFACE PRINT  INTERLAYER PRINT  GRAPHIC DESIGN



10
COLOURS



SUPER GOLD
AND SILVER
EFFECT
(SUPER SILVER
PAINT PRINTING)

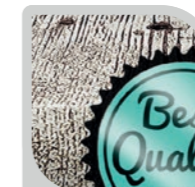

PAPER
IMITATION
PRINTING
("TOUCH
EFFECT")



GLOSS/MAT
EFFECT



SYNCHRONISED
DOUBLE-SIDED
PRINTING
10+10



HIGH
RESOLUTION
PRINT